

Silver Sea-ox

Haier Household Electric Water Heater

User's Manual

Haier

FCD-JTHMG50-III (E)

FCD-JTHMG60-III (E)

FCD-JTHMG80-III (E)

FCD-JTHMG100-III (E)

Haier Group

Qingdao Economic and Technological Development District

Haier Water Heater Co., Ltd.

Add: Haier Garden, Qianwangang Road, Economic Development Zone, Qingdao, P. R. China

Website: <http://www.haier.com>

Rev. 01
Specific Number 0040501638

- Please read this manual before usage
- Retain it for future reference

Haier

Pre-safe Expert



Mark of Haier **Safe** Water Heaters

This mark is the designation for Pre-Safe Expert of Haier Water Heater Company, which indicates use of the company's patented technology inside the product. It ensures you a safe bath while monitoring whether your house ground wire is live or not all the time. If this mark is lighted on, it indicates your house ground wire has come live (poor grounding and live). In this case, please immediately stop use and unplug from the power supply, and remember not to touch any electric appliance shell in your house. At the same time, immediately contact after-sales service and your property management company for professional repair until the mark goes off.

Pre-Safe Expert will become the electric safeguard for your family.

Contents

Before USage	
Special reminding	2
Features	2-3
Views and parts	3
Safety precautions	4
Setting environment	5
Parameters	5
Dimensions	6
Installation	
Attentions in Installation	6
Installation	7
Operation	
Control panel illustration	8
Remote controller panel illustration	8
Operation instructions	8-12
Operation diagram	12
Attentions in operation	12
Use of remote controller	13
Electric Circuit Diagram	
Electric Circuit Diagram	13
FAQ*After service	
Cleaning and maintenance	14
FAQ	14
Packing list	14



Correct Disposal of this product:
 This marking indicates that this product should not be disposed with other household wastes throughout the EU. To prevent possible harm to the environment or human health from uncontrolled waste disposal, recycle it responsibly to promote the sustainable reuse of material resources. To return your used device, please use the return and collection systems or contact the retailer where the product was purchased. They can take this product for environmental safe recycling.

● See to the physical product for the appearance, color or pattern.

Cleaning and Maintenance

Statement: This water heater shall only be repaired and maintained by qualified servicemen. Improper maintenance may cause severe injury or damage.

Before opening or repairing water heater, please do pull out the power plug.

Note: Before asking for service, please refer to troubleshooting section to resolve easy problems.

- **External Cleaning:** Disconnect power supply before cleaning. Gently wipe with wet cloth dipped with a little of mild detergent. Do not use gasoline or other solvents. Finally dry with dry cloth. Keep water heater dry. Do not use cleansers containing grinding agent (e.g. toothpaste), acids, chemical solvents (e.g. alcohol) or polishers to clean.
- **Internal Cleaning:** To ensure high working efficiency, heating elements and tank liner of water heater shall be cleaned once in three years. Take care not to damage protection layer on heating elements and tank liner inner surface. According to different local water qualities and use habits, magnesium anode rod shall be periodically replaced. If maintenance is needed, please contact local service station.

FAQ

Problems	Possible Causes to be Confirmed	Corrective Measures
No outlet water	If water supply is stopped or water pressure is too low	Check
	If use point is blocked or if hot water valve is open	Check and clean
Outlet water is cold	If water temperature is properly adjusted	Re-adjust
	If thermostat is out of control	Contact service station
	Heating time is too short	Continue heating
Outlet water flow and temperature is not steady	If city water pressure is steady	Check
Unable to start machine	If components are damaged	Contact service station
Error display of E1	Circuit fault	Contact service station
Error display of E2	If tank is full of water or if components are damaged	Fill water full or contact service station
Error display of E3	If sensor is damaged	Contact service station

Packing List

Name	Water Heater (set)	Safety Valve (pcs)	Expansion bolt (pcs)	Expansion hook (pcs)	User' manual (copy)	Battery (pcs)	Remote controller (pcs)	Drain hose (ply)
Quantity	1	1	2	2	1	2	1	1

Use of Remote Controller

1. **⏻ button:** Power on / off the machine. In off status, clock time is displayed and can be adjusted by pressing Set button, and **▲** or **▼** button.
2. **Mode button:** With machine powered on, you can lightly press Mode button to shift between Real-time Heat / Warm, Medium Warm, Night Power, Time 1, Time 2, Time 1+Time 2 and Intelligent operation modes. In Medium Warm mode, default highest temperature is 40°C and can't be adjusted. In Time 1 and Time 2 modes, default heating power is 2150W and can't be adjusted.
3. **Power button:** With machine powered on, press this button to shift heating power level between 850 W, 1300 W and 2150 W.
4. **▲ or ▼ button:** Same as Adjust button on control panel. If not in clock or delay time adjusting status, you can use **▲** or **▼** button to increase or decrease temperature setting value between 35°C - 75°C with an increment 1°C. If in clock or delay time adjusting status, these buttons can be used to increase or decrease time.
5. **Set button:** Press it to set clock time, and press **▲** or **▼** button to adjust the value. Press Confirm button after adjusting. In Real-time Heat / Warm mode, press Set button to adjust clock hour and minute together with Confirm button. In Time 1 mode, press Set button to set Time 1 hour and minute. In Time 2 mode, press Set button to set Time 2 hour and minute. In Time 1 + Time 2 mode, press Set button to set Time 1 hour and minute, and Time 2 hour and minute. In addition, in Medium Warm mode and Intelligent mode, Set button is inactive.

Notes:

1. Remote controller buttons (except Set button) are used in the same way as buttons with same name on control panel. After adjustment is made with Set button, press Confirm button to confirm.
2. Remote controller has a memory function. Upon re-starting after powering off, original settings keep unchanged.
3. As an optimum, remote controller shall be used in short distance pointing to the machine vertically. Water immersion shall be avoided. If battery is used up, to prevent battery liquid pollution, please open battery cover in indicated direction, remove used batteries and replace with new batteries installed as original. To avoid explosion, used batteries shall not be kept in hot places or put in fire, but shall be treated in accordance with related local regulations.

Electric Circuit Diagram

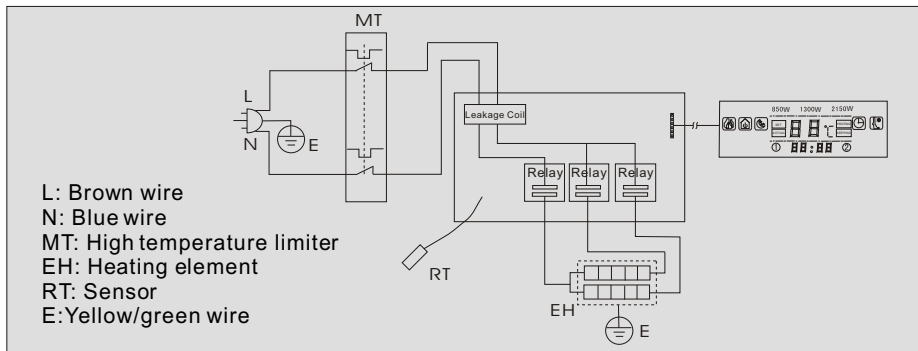

Before Usage

Dear users,

Thanks for choosing Haier water heater product.

Haier products have good quality and excellent performance. To facilitate you to use the product, please read the manual and operate accordingly. Please retain it for future reference.

The international star service of Haier Group will always accompany you. No matter what kind of problems you meet in usage, please contact with the local after-sales service agent. We are at your service all the time. Thanks again for choosing Haier Product.

The water heater you purchased may not fully comply with the manual due to the improvement of product. We apologize for the inconvenience occurred therefrom.

Special Reminding

To ensure proper and safe use of the water heater, we hereby sincerely declare that users shall contact our designated professional service providers for installation and service. For inappropriate installation, Haier would not undertake any liability.

- Do not disconnect the power supply before any maintenance and repair on the water heater. Unprofessional persons shall not adjust or repair the water heater.
- Make sure the machine is full of water before powering it on, otherwise heating element may be damaged. Do ensure power socket complies with local standard and is reliably grounded. Ungrounded use is forbidden.
- This electric water heater is provided with a safety valve, which shall not be randomly relocated or blocked.
- Hot water above 50°C may burn your skin. Do not mix hot water and cold water before showering or washing.
- At an ambient temperature below 0°C, possible ice formation within pipes may break the pipes and cause the machine inoperable. Protection shall be made by emptying water in the tank. In case the water heater will not be used for more than 1 month, please empty the water and unplug the power plug.
- If the electric water heater is heavily wetted by water, it should be checked by our authorized technicians before next use.
- Hot water inside the water heater is not drinkable. Due to long time use, sediments will form inside the tank, and water quality may also deteriorate due to pipe aging. After washing rice and vegetables with water from the tank, please flush again with clean water.
- Please do not place flammable matters like gasoline nearby the water heater, otherwise accidents like fire may occur.

Features

1. High Technology:

Full PC controlled. Display indicates the actual water temperature, temperature setting, clock and working state. Upon faults, power supply is automatically cut off and the display indicates fault code.

The intelligent heating feature reflects a more humanized design.

Features

2. Safe:

High-quality imported heat-resistant stainless steel heating element, corrosion resistant and more reliable. Fuzzy control with over-temperature protection, tank liner over-pressure protection and current leakage protection. "Safe Care" patented design together with the function of monitoring and displaying of live ground wire has become a real safeguard for family safety.
3. Durable:

Specially treated shell. Elegant and durable.
Tank liner produced with 3-layer liner enameling technology. More reliable quality.
4. Energy Saving:

One-piece PU foaming technology, thermal insulative and power saving. Two delayed water use times manually set, easy and energy saving.
Three power levels. Upper and lower heating elements. Save energy in both winter and summer.
Night power feature and Medium temperature warming feature, free selection as you desire.
5. Easy to use:

Water heating temperature adjustable between 35°C - 75°C in an increment of 1°C.
Outlet water temperature adjustable between inlet temperature and 75°C.
6. Power Failure Memory:

Patented PC board design. Machine automatically memorizes setting information before power failure, and directly goes to previous working status upon power resumption.
7. Multi-purpose:

Closed structure suitable to connect several outlets for water use in locations like washroom and kitchen. (outlet water is not suitable to drink)
8. Horizontal installation, space saving.

Options of local control or remote control.

Your water heater is an improved product of this series. Please use it as instructed in this manual.

Views and parts

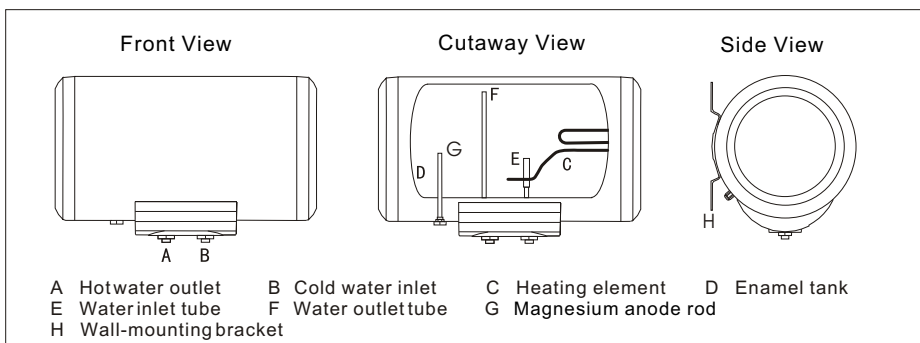

Operation Instructions

D. In non-heating intelligent mode, machine stays in standby status. You can activate interface by pressing any button on the control panel (buttons on remote controller are inactive).

Operation Diagram

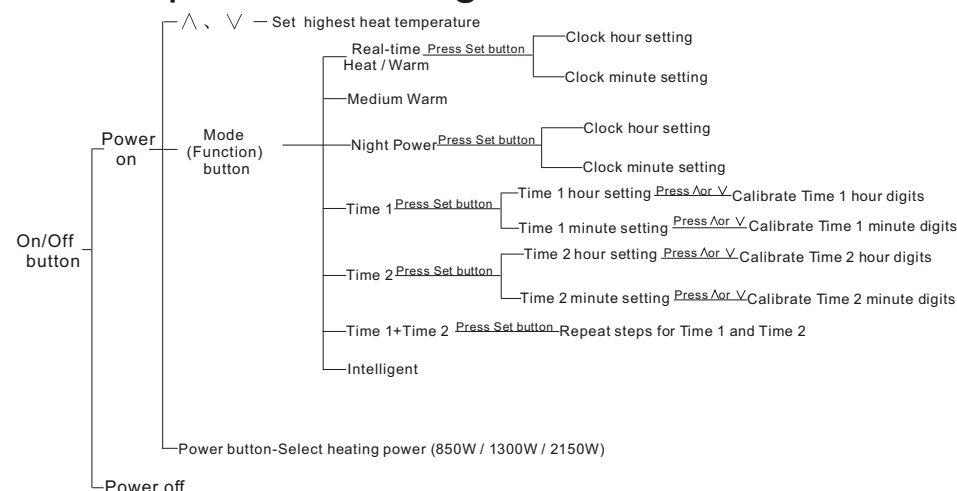

Attentions in Operation

1. To avoid causing machine troubles, do not connect power before tank is full of water.
2. Adjust a suitable temperature before use, for water temperature above 50°C may burn your skin.
3. This product is closed water heater, which can supply hot water through pipe connection to several points like bathroom (bathtub, washbasin, showerhead) and kitchen.
4. Heating adjustment can be made flexibly all year round adapting to climate changes. In long-term out-of-use or maintenance, you can close city water pipe valve, open mixing valve, and move up safety valve handle to drain the tank. To avoid injury, before next use, it is suggested to first open hot water valve before switching on the water heater, exhausting gas possibly retained in the pipeline. In this case, no smoke or fire is permitted near the open valve. Carefully check and confirm all parts are in good condition.
5. Provided hot water quantity can meet use demand, temperature setting shall be possibly low. It can minimize heat dissipation, high-temperature corrosion and sedimentation, ensuring a longer service life.
6. Regularly ask servicemen to make safety inspection, remove sediment on heating elements, and check consumption of anode bar. Too much consumed anode bar shall be replaced.

Operation Instructions

9. Delay Time Setting

Delay function means that, system automatically calculates the time needed to reach temperature setting value with a defaulted 2150 W power, then determines the time to start heating, and automatically heats to the set temperature before the preset delayed time to use hot water. Two Delay Times (Time 1 + Time 2) means machine as needed can heat water in two delayed use times. This machine can be manually set two delayed water use times. Setting will take PC clock time as reference. Defaulted Time 1 use time is 17:00 and Time 2 use time is 06:00. In Delay mode, system default heating power 2150 W can't be adjusted.

Example: as shown in Fig. 12, set delayed use Time 1 at 10:30.

With machine powered on, consecutively press Mode button until it enters Time 1 operation status with delay indication and symbol ① lighted. Press Set button to enter Time 1 hour setting status with Time 1 hour digits flashing. Press \wedge or \vee button to get 10:00. While hour digits are flashing, you can press Set button to confirm and enter Time 1 minute setting. Adjust the value to 10:30 with \wedge or \vee button.

Then you may press Set button to confirm current settings or wait 6 s after which machine automatically confirms and quits. Time 2 time setting is similar to Time 1, i.e. press Mode button to enter Time 2 operation mode and set Time 2 time with Set button.

Note: If large quantity hot water is used after delay mode is started and water heaters starts heating, resulting in water heater still hasn't reached temperature setting at delayed use time, machine will automatically extend heating for half an hour and stops. If actual temperature has reached setting value before delayed use time, and it decreases by 5°C before reaching delayed use time, machine will calculate heating time again and determines if re-heating is needed or not. Likewise, if water heater hasn't reached set temperature at delayed use time due to too low supply voltage, machine also automatically extends for half an hour and stops.

10. Operation Mode Selection

After powering on, by consecutively pressing Mode button, system will shift between Real-time Heat / Warm (with Real-time indication), Medium Warm (with Medium Warm indication), Night Power (with Night Power indication), Time 1 (with Delay and ① indication), Time 2 (with Delay and ② indication), Time 1 + Time 2 (with Delay and ①, ② indication) and Intelligent (with Intelligent indication) modes. User can select any mode as current operation mode. Only after being selected as current operation mode, corresponding settings can be executed.

Example: clock at 7:00, heating power of 2150 W, temperature setting of 75°C (temperature setting and actual temperature flash alternatively), delayed use Time 1 being set at 10:00. If you want to use water at 10:00, after settings are made, you must press Mode button to adjust current mode as Time 1 mode. Machine will automatically heats water to set temperature at 10:00. Otherwise (e.g. in Night Power mode as shown in Fig. 13), it doesn't execute Time 1 function. You need to select Delay and symbol ① with Mode button, and then Time 1 function can be executed.













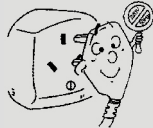



11. Powering Off

After taking shower, you can lightly press On/Off button to power off the machine.

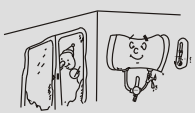

Hints:

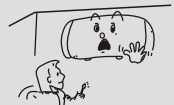
- With machine powered on, you can press Set button to set On/Off time for various modes, and adjust time with \wedge or \vee button. In Real-time Heat mode, you can press Set button to adjust clock hour and minute values. In Delay mode, you can press Set button to set delayed use time. In Medium Warm and Intelligent mode, Set button is inactive.
- The machine has multiple safety means like current leakage protection, over-temperature protection, sensor short-circuit and open-circuit protection, which can realize full disconnection and display fault code. All fault protections are unrecoverable protection which needs local after-sales service.
- This water heater has power failure memory function. You needn't re-set heating power level, heating temperature, clock and operation mode. Machine will directly go to previous working status after powering on again.

Safety Precautions

  <p>Check if power meter and wire size are consistent with water heater rated current. If necessary, ask experienced qualified electricians to check.</p>	  <p>The water heater shall use 230 V~ / 50 Hz power supply from a separate socket (no multi-purpose socket) and be reliably grounded. Power plug pins shall be cleaned in time to avoid any contamination causing accidents like fire.</p>
  <p>Do not use damaged wire, socket or appliances with loose plug, otherwise accidents like electric shock, short circuit and fire may occur. Make sure power plug closely fits with power socket.</p>	  <p>Power socket for water heater shall be located in a dry place free of water spray. Do not insert or pull the power plug with wet hands, for accidents like electric shock or injury may happen.</p>
  <p>For first use after installation, the tank must be full of water before connecting the power. Otherwise, heating element overheat may cause troubles. Children taking shower must be attended by adults.</p>	  <p>Please do not point the showerhead towards human body when turning on or off the faucet, avoiding to be scalded by a small stream of hot water.</p>
  <p>In winter in cold regions, for long-term out-of-use, please lift the safety valve handle to empty the water, avoiding ice formation damaging the water heater.</p>	  <p>Damaged power cord must be replaced by after-service technicians with special cable (factory provided). Other persons shall not dismantle or repair. In addition, do not place flammable matters nearby the water heater.</p>
<p>Temperature value indicated on the display is for water around the detection point. Outlet water temperature is generally higher. Before use, please first turn on cold water and then adjust water temperature as you need. During use, the displayed value is still water temperature at detection point instead of outlet temperature. Please do not directly turn on hot water.</p> <p>The product adopts Haier "Safe Care" patented technology. In normal installation, even in severe case that ground wire is live due to wrong connection, the product "Safe Care" technology can filter and efficiently ensure your safety. However, whenever you feel a sensory current, please pull out the power plug and notify local after-service men in time. Do not dismantle by yourself.</p>	
<h3>Description of the Symbols</h3>	
<p> Never do that</p> <p> Be sure to act as per instructions</p>	

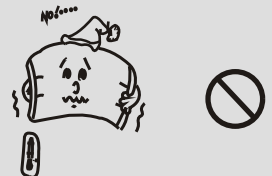
Setting Environment

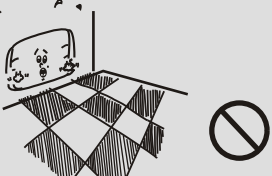
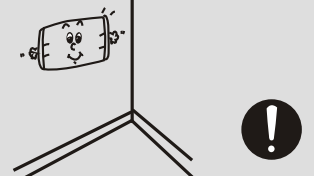
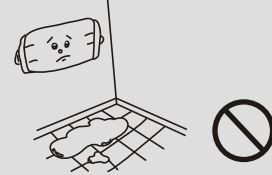
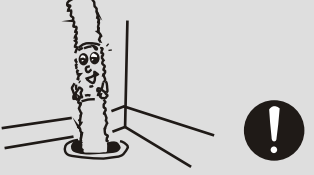
 <p>Do not locate in freezing places. If ice forms, tank and pipes will break, causing scalding and leakage.</p>	 <p>Do not install it outdoors.</p>
 <p>Do not install it as stand-alone.</p>	 <p>It shall be hung on firm and solid wall.</p>
 <p>Do not install it in places unable to drain water.</p>	 <p>If a drain hose is connected, it shall be connected to sewage drain, avoiding spilling the room.</p>
<p>The tubes and pipes fitted on the product are inseparable parts of the "Safe Care" technology, and shall not be removed by yourself. Otherwise, Haier shall not be liable for any damages or injuries caused due to resulted potential risks.</p>	
<h3>Description of the Symbols</h3>	
<p>⊘ Never do that ! Be sure to act as per instructions</p>	

Parameters

Rated voltage: 230V~, 50Hz

Power: 850 W /1300 W /2150 W

Rated pressure: 0.75Mpa

Waterproof grade: IPX 4 (▲)

Dimensions: (see to Fig. 1)

Weight: (see to Fig. 1)

Volume: (see to Fig. 1)

Tap water pressure: not less than 0.05 MPa

Operation Instructions

Water heater automatically sets an energy saving temperature between 35°C - 40°C according to the difference between water temperature and ambient temperature (normally this medium temperature can ensure small demand but not shower. For shower, you need to quit Medium Warm mode, and press Mode button to enter Real-time Heating / Keeping mode. Then the water can be heated to the setting temperature in a short time.). When water temperature decreases to 34°C, machine automatically restarts heating. Heating power level can be manually set with Power button.

Example: Fig. 10 shows Medium Warm mode. Press Power button to set power level 2150 W with corresponding indication lighted. The actual temperature then is 52°C. When it decreases to 34°C, machine will automatically re-heats to 40°C and keeps warm. It cycles in this way. In this mode, the machine defaulted highest heating temperature 40°C can't be adjusted.

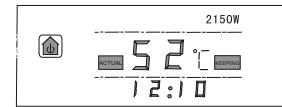

(Fig.10)



(Fig.11)

7. Night Power Setting

With machine powered on, as described in Item 10, consecutively press Mode button until it enters Night Power operation mode (with Night Power indication on the display). If you would use hot water in early morning, you may adjust operation mode to Night Power mode. Machine will heat / warm in default period (0:00 on and 6:00 off). Heating power level and highest temperature can be manually set. In this mode, you can press Set button to calibrate clocktime.

In addition, in regional power consumption regulations, night power price rate is lower than in day, so Night Power mode will be easier and more economic.

Note: In selecting Night Power function, water heater clock shall be adjusted to local time. Inaccurate clock will cause night period partly charged as day use. (Only for regions with Peak and Valley Electricity Rates)

Example: With machine powered on, press Mode button to select Night Power mode. When PC clock displays 00:00, machine automatically starts heating. It enters warm status after reaching setting value and has thermostat control during 0:00 ~ 6:00. (see Fig.11)

8. Intelligent Heating Function

Intelligent heating function means that the system can analyze, process and memorize user's water use habits in one week, and accordingly heat water in advance automatically. With machine powered on, consecutively press Mode button until it enters Intelligent operation mode with intelligent indication lighted on. System automatically starts heating in the first memorized heating time since then. Heating power and highest temperature can be manually set.

In non-heating period, system remains standby with clock and intelligent indications lighted on. After it reaches the heating temperature, the machine will start to heat automatically. If you'd like to quit Intelligent Heating mode and enter another mode, you can press any button on control panel to activate the interface (buttons on remote controller inactive), and then press Mode button to shift modes.

Notes: 1. In any mode after powering on, Intelligent Heating function can memorize your water use habits. If you bathe in a fixed period everyday several times a week (4 times or more than 4 times), system will analyze and memorize your this habit and automatically start heating in advance.
 2. Only in Intelligent mode can Intelligent function be executed.

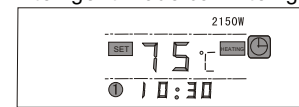

(Fig.12)

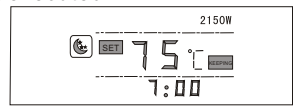

(Fig.13)

Operation Instructions

2. Temperature Setting

With the machine powered on (with no any digits flashing on the display), press \wedge or \vee button to enter temperature setting status with the temperature digits rapidly flashing. Temperature can be changed between 35 - 75°C with an increment 1°C. In real-time heating mode, you can directly press \wedge or \vee button to adjust temperature setting value. In medium warm status, machine defaulted highest temperature is 40 °C and can't be adjusted. If actual water temperature is lower than setting value and the machine is in medium warm mode, you need to change operation mode to real-time heating mode, and then the machine can heat water to the set temperature.

3. Clock Calibration

Clock goes in 24-hour and 60-min system in a second flashing way.

Example: calibrate the clock to 11:29

After powering on, in real-time heating and night power modes, you can press Set button to enter clock calibration status with hour digits flashing. Press \wedge or \vee button to set 11. Press Set button again and minute digits flash. Press \wedge or \vee button to set 29. You can press Set button to confirm current setting, or wait 6 s after which the system will automatically confirms and quits setting status (as shown in Fig. 7, machine is in real-time heat / warm mode).

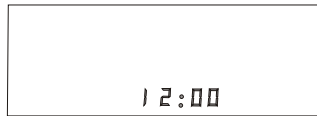

Fig.6

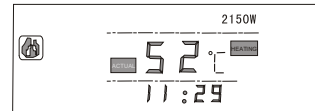

Fig.7

4. Power Level Selection

With the machine powered on, press Power button to directly go to power level selection status. You can select a power level 850 W, 1300 W or 2150 W. If 850 W is selected, 850 W digits are lighted and only the upper heating element works. If 1300 W is selected, 1300 W digits are lighted and only the lower heating element works. If 2150 W is selected, 2150 W digits are lighted and both the upper and lower heating elements work. In Delay mode, machine defaulted heating power is 2150 W and can't be adjusted. Fig. 8 shows a heating power level 2150 W, the present clock time 12:10, and the real-time heating mode.

5. Real-time Heat / Warm Setting

With machine powered on, as described in Item 10, press Mode button to enter Real-time Heat / Warm mode with real-time heat indication lighted on. According to settings, machine will automatically start to heat or keep warm. The machine has a thermostat function, by which, the machine goes into warm keeping status when it reaches the temperature setting value. In warm keeping status, machine automatically starts heating when actual water temperature is 5°C (for setting value lower than 55°C) or 10°C (for setting value equal to or above 55°C) lower than the setting value, until reaching setting temperature again. It repeats in this way.

Example: Fig. 9 shows real-time heat / warm status with heating power 1300W and temperature setting 75°C.



Fig.8

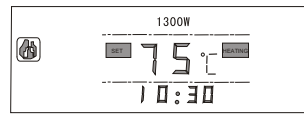

Fig.9

6. Medium Warm Setting

With machine powered on, as described in Item 10, press Mode button until it enters Medium Warm operation mode (with Medium Warm indication on the display).

Dimensions

(Fig.1)

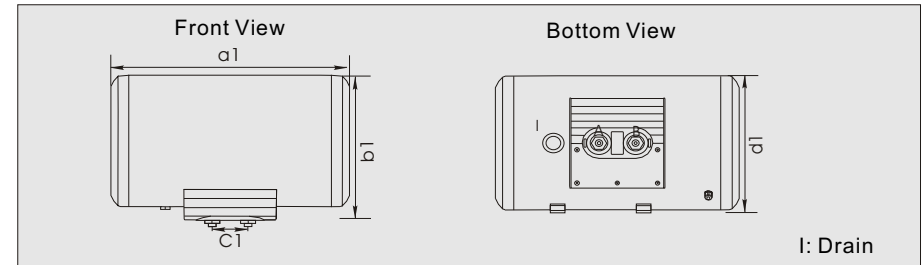

Model	Volume	Net Weight	a1	b1	c1	d1
FCD-JTHMG50-III (E)	50L	22kg	671mm	442mm	100mm	410mm
FCD-JTHMG60-III (E)	60L	25kg	765mm	442mm	100mm	410mm
FCD-JTHMG80-III (E)	80L	29kg	876mm	479mm	100mm	450mm
FCD-JTHMG100-III (E)	100L	34kg	1052mm	479mm	100mm	450mm

Remarks: the permitted error limit of above parameters is $\pm 10\%$.

Attentions in installation

- During installation, adequate space must be reserved for future maintenance and repair. If the water heater is installed within decoration boards, the right board shall be removable to facilitate removing the plastic cover during maintenance.
- City water inlet pressure shall not be less than 0.05 Mpa.
- Electric water heater shall be installed indoors with ambient temperature above 0°C. The pipes shall be collectively laid. Hot water outlet shall not be too far from use points. In case farther than 8 m, hot water pipe shall have a thermal insulation to minimize heat loss.
- The mounting wall shall be firm and reliable to support twice the weight of water heater full of water. Non-load bearing walls or air brick walls must have corresponding protective measures like additional support, wall-through screws or backboards.
- Electric water heater shall be located in a place easy for use, maintenance and with a floor drainer. In case the tank or pipes leak, nearby or lower facilities shall not be damaged. The installation location shall avoid being above toilet bowl, bathtub, washbasin or doorframe, where will cause a suppressed or unsafe feeling to users.
- Power socket for water heater shall be in a dry place free of water splash to avoid nonnormal work of the water heater. (splash-proof box is preferred)
- Do not confuse inlet and outlet water pipes. Safety valve shall be installed at designated position with no random modification. The safety valve pressure relief vent shall keep open to the air. Do not block it.
- To ensure safety, water heater shall use a separate socket (not multi-purpose socket) and be reliably grounded. Socket quality shall comply with local standard. Check with a neo-electroscope the line and neutral are not wrongly connected. Only after confirming the tank is full of water, no water leakage at various connections and power supply meets requirements, power can be turned on to start heating.

Installation

- Installation must be made by installers of or designated by our company after-service department. The water heaters shall be wall-mounted.
- Before installation, make sure water heater rear wires are fit firmly. Determine an installation location. Make four holes ϕ 12mm, 65 mm deep in the wall with an impact drill as shown in Fig. 2. Insert and fix expansion hooks and expansion bolts in corresponding wall holes. Lift the water heater. Insert wall rack onto the hooks and bolts. Fit flat washers, rear wires and nuts in turn onto the bolts (see Fig. 3). Tighten the nuts and check them firm. Install accessories such as safety valve, drain hose as shown in Fig. 4. Use sealing compound to prevent water leakage.

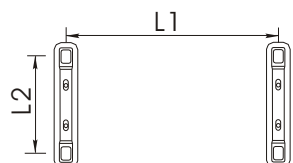

(Fig.2)

Capacity	50L	60L	80L	100L
L1	200mm	300mm	282mm	370mm
L2	320mm	320mm	320mm	320mm

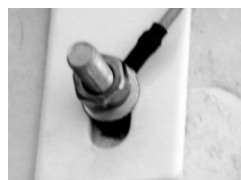

(Fig.3)

- To facilitate installation and removal, it is suggested a G 1/2" movable nut is fitted at appropriate locations on inlet and outlet pipes respectively. Find water supply location. Connect inlet pipe, outlet pipe and city water pipe respectively to the use point. Fill the tank full of water and check if water circuit shows any leakage. For any leakage, re-connection shall be made.

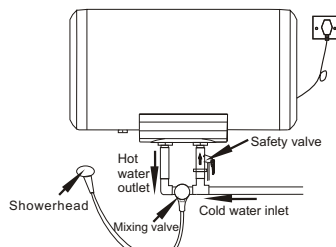

(Fig.4)

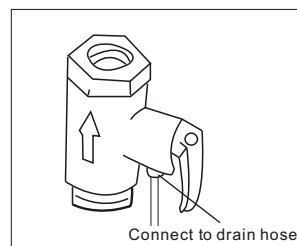

(Fig.5)

- Note:** Make sure the wall rack is reliably hung on the hooks before releasing your hands. Otherwise, the water heater may fall and cause human injury or property loss.

Connection and Use of Safety Valve:

- The safety valve should be connected to the cold water inlet pipe. Please check carefully if the direction is correct after installation. The correct direction of installation is that the arrowhead on the safety valve should be pointed to the water heater.
- Please connect the drain hose to the safety valve. Connect one end of the hose to the safety valve vent and the other end to the sewage drain. The hose can be cut short or extended as necessary. The hose shall be installed as inclined downward.
- The water may drip from the discharge pipe of the pressure relief device and that this pipe must be installed in a continuously downward direction and in a frost-free environment. Check safety valve once a month as follow: move the small handle of safety valve, if there's water flowing out, safety valve is normal; if there's no water flow, please contact local after-sales service station.
- The pressure relief device is to be operated regularly to remove lime deposits and to verify that it is not blocked.

Control Panel Illustration

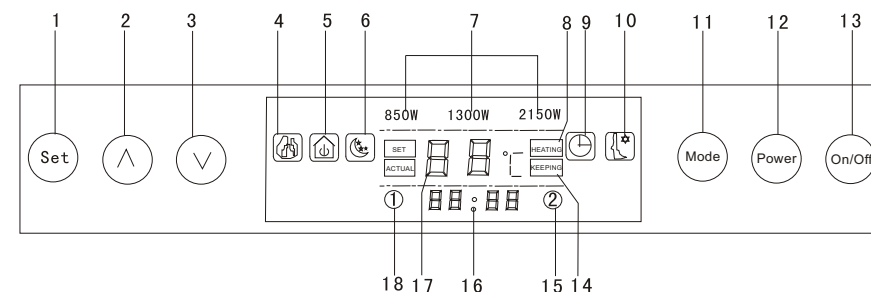

1. Set Button
2. Temperature and Clock Time Increase Button
3. Temperature and Clock Time Decrease Button
4. Real-time Heating Indication
5. Medium Warm Indication
6. Night Power Indication
7. Heating Power Indication Area
8. Heating Indication
9. Delay Indication
10. Intelligent Indication
11. Mode Button
12. Power Level Selection Button
13. On/Off Button
14. Warm Keeping Indication
15. Time 2 Indication
16. Clock Time Display
17. Temp. Setting / Actual Temp Display
18. Time 1 Indication

Remote Controller Panel Illustration

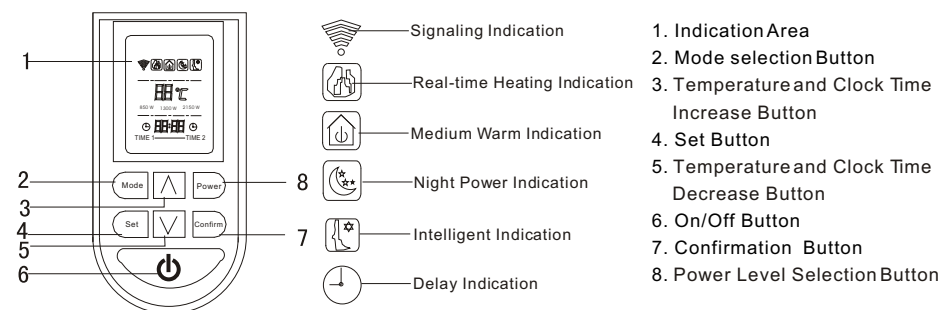

1. Indication Area
2. Mode selection Button
3. Temperature and Clock Time Increase Button
4. Set Button
5. Temperature and Clock Time Decrease Button
6. On/Off Button
7. Confirmation Button
8. Power Level Selection Button

Operation Instructions

For the first use after installation, due to there's no water within the tank, first the city water inlet valve and mixing valve must be opened. Close the mixing valve when water flows out continuously from the showerhead or other outlets (the tank is full). Check connections are free of water leakage, and insert the power plug.

1. Powering On

This product has a power failure memory function, i.e. it remembers temperature setting, power level, clock and current working status. Upon connecting power, all indications on the display are displayed for 2 s before the system goes into standby status (with only clock display and all buttons except On/Off button inactive) or previous working status before power failure with corresponding indicators lighted on. For example, machine as shown in Fig. 6 is in standby status with only On/Off button active.